

LED Fluorescent Tube Light

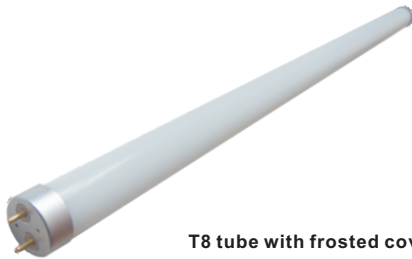

T8 tube with wave cover

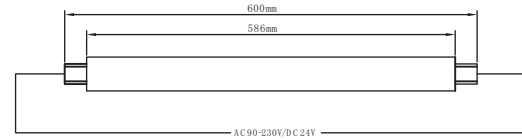

T8 tube with frosted cover

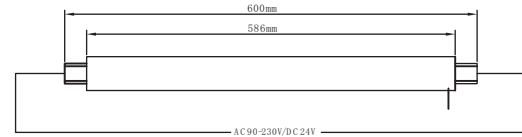

T8 tube with clear cover

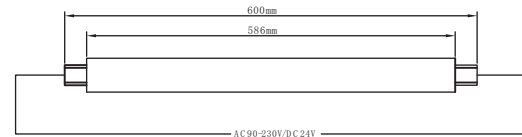

- Acrylic front cover and nice polishing aluminum back cover
- Besides the protecting housing, acrylic cover works also as LED lens
- Standard length available in 1.5m, 1.2m and 0.6m. Custom length accepted.
- Voltage available in 65-265V AC, 277V AC, 12V DC and 24V DC
- Run without existing ballast/starter from conventional fluorescent
- Engineered to the best level of light output maintenance
- Using super bright SMD LEDs, high output 1150 lumens
- Lifespan over 50,000 hours and standard warranty 3 years
- Energy saves more than 70% comparing conventional 40W FTL
- No hazardous materials, fully RoHs compliant
- No flickering or RF interference

LED Fluorescent Tube Light

SC-FTN-T5

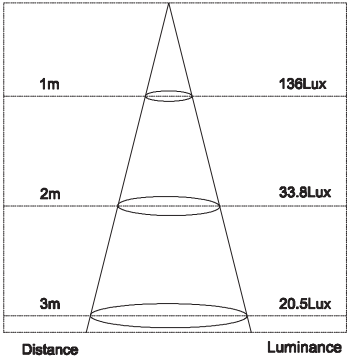
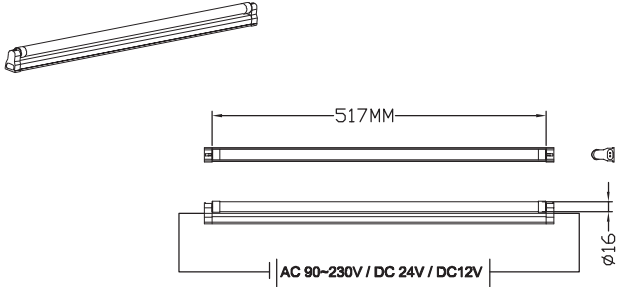
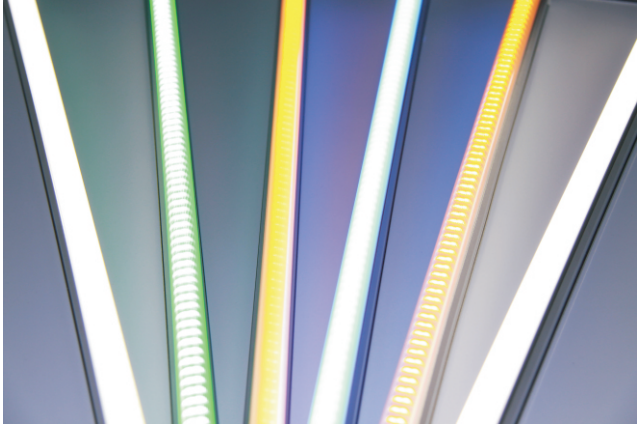

A	Wall
B	Bridge bracket
C	Screw
D	Bracket
E	LED T5
F	Connector

